

C-SERIES MINI EXCAVATORS
CX26C | CX30C | CX33C | CX37C

CASE
CONSTRUCTION



**READY FOR THE
CHALLENGE**

www.casece.com
EXPERTS FOR THE REAL WORLD
SINCE 1842

CASE BRAND HERITAGE

MORE THAN 175 YEARS OF PRIDE AND COMMITMENT



EXPERTS FOR THE REAL WORLD SINCE 1842

- 1842** Jerome Increase Case founded Racine Threshing Machine Works in Racine, Wisconsin, USA.
- 1912** CASE manufactures road building equipment.
- 1969** CASE begins skid steer loader production.
- 1988** CASE recognized by Fortune magazine: listed by Fortune magazine among the "100 Products America Makes Best."
- 1995** CASE expands attachment offering: co-branding and supply agreements with several key attachment suppliers.
- 2011** CASE leads Tier 4 solutions.
- 2011** Long Enters Hall of Fame: CASE engineer, "father of the loader/backhoe", is inducted into the Construction Equipment Hall of Fame.
- 2016** CASE starts the production of C-Series mini excavators up to 5t in San Mauro Plant for the global market.

SAN MAURO PLANT AWARDS



ISO 9001
Product quality
since 2008



ISO 14001
Environment quality
2004



ISO 18001
Safety management
2007



ISO 50001
Energy management
2011

VERSATILITY AND CONVENIENCE



HIGH EFFICIENCY

Clean engine and Auto-idle system

- Proven, reliable, fuel efficient, low emission and low noise Kubota T4 Final (Stage V) engine (CX26C and CX30C).
- Reliable and environmentally friendly T4 Final (Stage V) Yanmar engine (CX33C and CX37C).
- Standard “Auto-idle” on CX33C and CX37C: The engine automatically decelerates to idling speed after five seconds of inactivity. This means less fuel consumption, less noise and less overall wear.



HIGH VERSATILITY

Match different customer needs

- **Working range**
 - Dig further with C-Series Minis: maximum reach is now + 10 % higher compared to the previous series.
 - Load high-sided trucks easily: best-in-class dump clearance combined with superior stability make truck loading an easy task.
 - Save time: C-Series Minis deliver faster cycle times in every combined operation, thanks to their excellent boom slewing speed.
 - Choose the most suitable arm for you: C-Series Minis match different customer needs, high breakout force with short arms or outstanding digging depth and reach with long arms.
- **Attachments:** get the most of your CASE mini with the integrated range of attachments.
- **Lifting:** all models can be fitted with an additional bolt-on counterweight that further increases stability and lifting capacity. For safe lifting operation machines can be fitted with a certified Object Handling Kit.
- **Travel:** all models have the standard «auto shift-down» feature that optimizes travel speed and traction. Travelling in 2nd speed the machine automatically shifts to 1st gear if it needs more traction, then automatically shifts back to 2nd gear when no extra traction is required and travel speed can be increased.

C-SERIES MINI EXCAVATORS



COMFORT COUNTS

Comfortable and durable cabin with suspension seat

- CASE CX26C, CX30C and CX37C feature a roomy cab with reduced sound levels and excellent visibility. Ergonomically placed joysticks and adjustable wrist rests make the Operator station a pleasant place to work in.
- Standard equipment: weight adjustable suspension seat, radio USB with 2 speakers, multiple storage compartments, Air conditioning (optional for CX37C).
- Sliding fold-in front window easy to open and safely stored in an open position to improve ventilation and visibility (Cab type).



MODERN AND FUNCTIONAL CLUSTER

Easy-to-read digital cluster

The digital cluster is easy to read, confers a modern look to the operator station and provides useful information:

- Gauges: fuel level, engine coolant temperature
- Info and warning lamps: hydraulic QC lamp, travel speed, engine coolant temperature, engine oil pressure, battery charging, low fuel level

PEACE OF MIND

ESL Anti-theft



• All C-Series minis are equipped with a standard anti-theft. It is an Engine Start Limitation (ESL) requiring a 5-digit code that can be set by the operator

• 3 possible settings:

1. Always: ESL is engaged every time the machine is shut off
2. Interval: ESL is engaged after a pre-defined interval of shutt off engine
3. Disabled ESL: ESL is not active

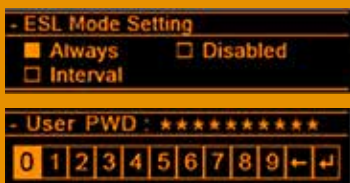

VERSATILITY IN SAFE CONDITIONS



SAFETY FIRST

C-Series Minis: no compromise on safety

- **ROPS / TOPS / FOPS:** all C-Series models and versions comply with Roll-Over / Tip-Over and Falling Objects –Protective-Structure requirements.
- **Emergency stop switch:** this switch allows to immediately stop the engine in case of an emergency.
- **Pilot system with accumulator:** this standard feature allows the operator to put the attachment down safely even with engine turned off for greater safety.
- **Travel alarm:** an acoustic alarm alerts the people near the machine when it moves forward or backward. This feature is optional on all four models.
- **Blade safety valves:** prevent the load from slipping or dropping due to hose failure (optional on CX33C and CX37C).
- **Double-flange rollers:** de-tracking can be dangerous for the operator and the people near the machine. CASE C-Series minis have a double-flange roller design that minimizes the risk of de-tracking.
- **Zero Tail Swing (ZTS):** the ZTS design means no risk of hitting obstacles with the rear of the machine when swinging, and creates less obstruction to road traffic.
- **Object handling kit:** includes safety valves on boom and arm, lifting hook on bucket linkage, and an overload alarm to handle heavy weights safely.

CASE
CONSTRUCTION

SiteWatch[™]

All models are Site Watch telematics pre-wired.

MAIN REASONS TO CHOOSE THE C-SERIES



EXCELLENT WORKING RANGE

- Long and short arms available
- Best-in-class reach, dump clearance and digging depth
- Ample boom swing angles



HIGH VERSATILITY

- Offering of integrated attachments
- Mono or bi-directional hydraulic oil flow
- Additional counterweight available
- Steel tracks available (CX33C and CX37C)



GREAT RELIABILITY

- X-frame undercarriage
- Cylinder protections
- Low risk of detracking with double-flange rollers



EASY TO TRANSPORT

- Light cab version
- Tie down hooks



GREAT STABILITY

- Higher overall width versus B-Series
- Double-flanged rollers



SAFETY FIRST

- ROPS / TOPS / FOPS certified Cab / Canopy
- Emergency stop switch
- Pilot circuit with accumulator
- Object Handling Kit (all four models)
- Blade safety valves (CX33C and CX37C)



COMFORT COUNTS

- Low noise inside the cab
- 1° and 2° auxiliary hydraulics
- Digital cluster
- Radio with USB
- Suspension seat
- Air Conditioning (CX37C)



HIGH EFFICIENCY

- Auto-idle function (CX33C and CX37C)

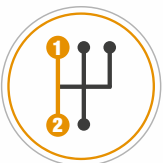

OPTIMIZED TRACTION AND SPEED

- Auto shift-down
- Rubber or steel tracks (CX33C and CX37C)



EASY SERVICEABILITY

- Easy access to battery, hydraulic valves and all regular service components
- Two-piece blade hydraulic hoses
- Extended life of components



C-SERIES MINI EXCAVATORS



GREAT RELIABILITY: A GIVEN ON CASE EXCAVATORS

World class components and a well-organized plant

- **World class components:** C-Series minis are designed for reliability, components are sourced from the best suppliers on the market and assembled in CASE's Excavator Hub, a World Class Manufacturing production plant. The result: simply highly reliable machines.
- **Boom and arm reinforced mounting pin:** the pivot pin that holds boom and arm together is a critical point on any excavator. On CASE C-Series the pin is secured from both sides minimizing the risk of play between boom and arm.
- **Protected cylinders:** boom and blade cylinders as well as safety valves are well protected with steel covers.



EASY AND SAFE SERVICEABILITY

Grouped service points under the hood

C-Series are designed for serviceability:

- Rationalized service points layout
- Convenient check points
- Easy-to-remove side panels for full maintenance and repair access
- Two-piece blade hydraulic hoses

GET THE JOB DONE NOW AND FOR MANY YEARS TO COME



STANDARD EQUIPMENT

- Standard arm (1120 mm on CX26C / CX30C; 1300 mm on CX33C / CX37C)
- Rubber tracks (250 mm on CX26C ; 300 mm on CX30C, CX33C, CX37C)
- ROPS / TOPS / FOPS compliant Cab / Canopy
- Emergency stop switch
- Pilot system with accumulator
- 2 speed travel with auto shift-down system
- 1st auxiliary 2-way circuit controlled with pedal
- Foldable boom swing pedal
- Suspension seat with seatbelt
- Radio / USB pre-disposition (Cab version)
- Standard anti-theft with interval setting function
- Waterproof digital instrument cluster
- Centralized greasing inlet

OPTIONAL EQUIPMENT

- Long arm (1350 mm on CX26C / CX30C; 1600 mm on CX33C / CX37C)
- 2nd auxiliary circuit controlled with joystick
- Hydraulic quick coupler provision
- Beacon
- Travel alarm
- Additional counterweight
- Air conditioner (CX37C)
- Steel track (CX33C and CX37C)
- Blade safety valves (CX37C)
- Object Handling Kit
- Radio with USB (Cab version)

Standard and Optional equipment may vary. Consult your CASE dealer for details.



IVECO

EUROCARGO

150-250

IVECO HASCOR



CASE

CASE

CX26C



C-SERIES MINI EXCAVATORS

SPECIFICATIONS

ENGINE

	CX26C	CX30C	CX33C	CX37C
Model _____	Kubota D1305		Yanmar 3TNV88F-ESHYB	
Displacement (cm ³) _____	1261		1642	
Rated gross horse power (hp/kW) _____ (ISO 14396)	24.8 / 18.5		24.4 / 18.2	
@ rpm _____	2400		2200	
Max torque (Nm/rpm) _____	81 / 1600		89 / 1200	
Emissions level _____	Tier 4F / Stage V		Tier 4F / Stage V	

HYDRAULIC SYSTEM

Variable displacement axial piston pumps		
- Pump delivery (l/min) _____	2 x 27.6	2 x 37.4
- Pressure (bar) _____	220	230
Gear pump delivery		
- Pump delivery (l/min) _____	19.6	23.1
- Pressure (bar) _____	175	205
1st Auxiliary 2-way Circuit		
- Pump delivery (l/min) _____	47.2	60.5
- Pressure (bar) _____	175	205
2nd Auxiliary 2-way Circuit		
- Pump delivery (l/min) _____	47.2	60.5
- Pressure (bar) _____	175	205

SLEWING & TRAVEL SPEED

	CX26C	CX30C	CX33C	CX37C
Slewing speed (rpm) _____	9.1	9.1	9.5	9.5
Boom slewing angle (left/right) _____	75° / 50°	75° / 50°	75° / 50°	75° / 50°
Travel Speed - Low (1 st) (km/h) _____	2.4	2.4	2.5	2.3
Travel Speed - High (2 nd) (km/h) _____	4.5	4.3	4.2	4.4

OPERATING WEIGHT & GROUND PRESSURE

(includes operator, full fuel tank and one bucket)

Cab (kg) _____	2650	3005	-	3760
Canopy (kg) _____	2500	2895	3095	3620
Ground pressure Cab (kgf/cm ²) _____	0.32	0.27	-	0.34
Ground pressure Canopy (kgf/cm ²) _____	0.30	0.26	0.28	0.33

TRANSPORT FEATURE

(weight is with full fuel tank, without operator, without bucket)

Weight (Cab) (kg) _____	2560	2915	-	3660
Weight (Canopy) (kg) _____	2410	2805	3005	3520
A Max length (Short / Long arm) (mm) _____	4030 4100	4180 4220	4640 4665	4790 4815
B Max height (mm) _____	2500	2500	2500	2500
C Max width (mm) _____	1500	1550	1550	1740



SPECIFICATIONS

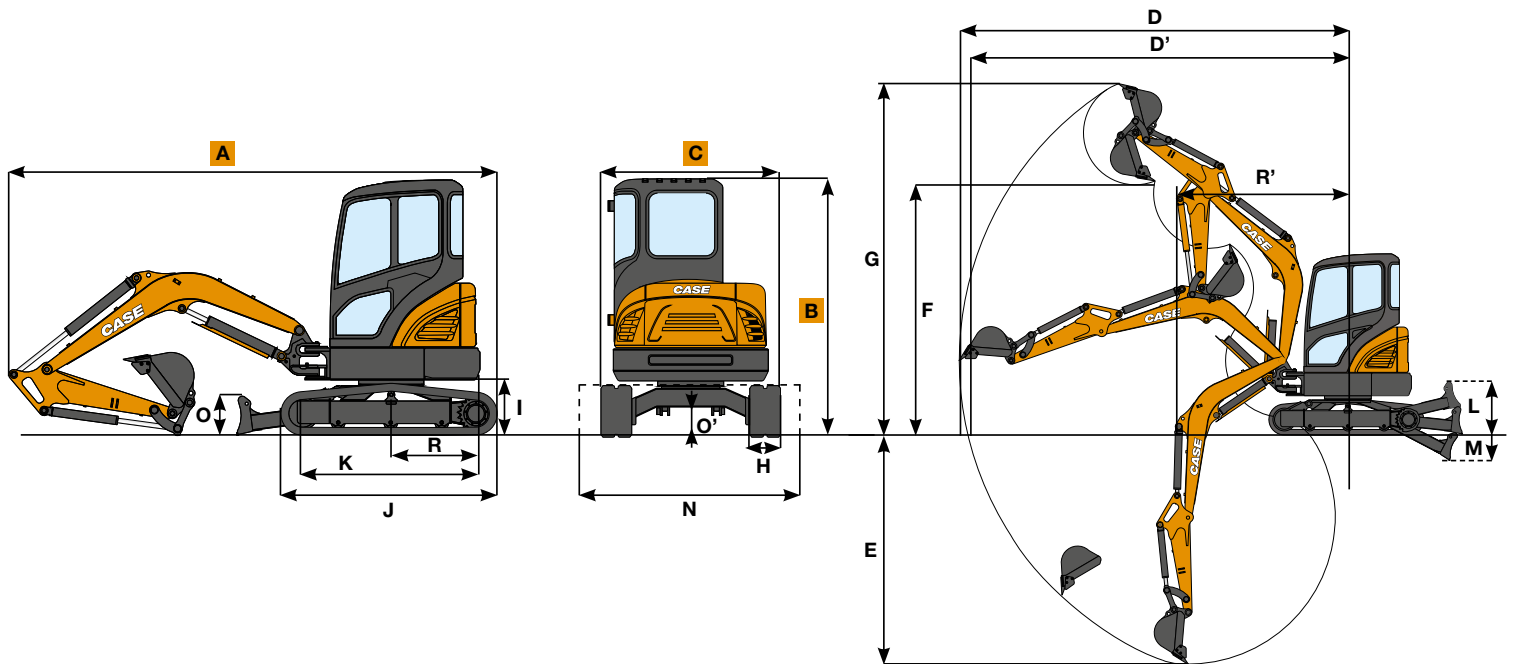

GENERAL DIMENSIONS

		CX26C	CX30C	CX33C	CX37C	
R	Rear end swing radius	mm	775	775	775	870
R'	Min front slew radius	mm	1980 - 1970	2055 - 2090	2290 - 2270	2350 - 2330
H	Track width	mm	250	300	300	300
I	Ground clearance of rear end	mm	510	540	540	540
J	Overall Length of Crawler	mm	1910	1970	2130	2130
K	Center distance of tumblers	mm	1490	1550	1700	1700
L	Blade max lifting	mm	330	350	400	375
M	Blade max lowering	mm	380	370	435	390
N	Blade width	mm	1500	1500	1550	1740
O	Blade height	mm	300	300	330	370
O'	Ground clearance of undercarriage	mm	290	290	290	290

DIGGING PERFORMANCES

		CX26C		CX30C		CX33C		CX37C		
Dipperstick	mm	1120	1350	1120	1350	1300	1600	1300	1600	
Dipperstick Breakout force (ISO)	kN	14.6	12.8	13,7	12,4	19.5	16.9	19.5	16.9	
Bucket Breakout force (ISO)	kN	21.1	21.1	20.1	20.1	31.4	31.4	30.7	30.9	
D	Max reach	mm	4480	4680	4650	4860	5180	5470	5315	5605
D'	Max reach at ground level	mm	4340	4540	4515	4735	5060	5355	5200	5495
E	Max digging depth	mm	2420	2645	2500	2720	3035	3335	3135	3440
F	Max dump height	mm	2930	3030	2890	3030	3275	3455	3425	3615
G	Max digging height	mm	4150	4235	4270	4405	4650	4840	4810	5010

C-SERIES MINI EXCAVATORS

LIFTING CAPACITIES

Lift point height (m)	Arm	LIFT-POINT RADIUS					
		2.0 m		2.5 m		3.0 m	

CX26C Canopy

Lift point height (m)	kg	LIFT-POINT RADIUS					
		2.0 m		2.5 m		3.0 m	
1.0 m	Blade up	760	620	530	440	400	340
	Blade down	*1690	670	*1130	480	*900	360
0.0 m	Blade up	710	570	500	410	380	310
	Blade down	*1700	620	*1450	440	*1100	340
-1.0 m	Blade up	710	570	490	400	370	310
	Blade down	*1910	620	*1360	440	*1030	330

CX26C Cab

Lift point height (m)	kg	LIFT-POINT RADIUS					
		2.0 m		2.5 m		3.0 m	
1.0 m	Blade up	880	720	610	510	460	380
	Blade down	*1470	770	*1030	550	*850	410
0.0 m	Blade up	810	650	570	470	430	360
	Blade down	*1580	700	*1420	500	*1070	390
-1.0 m	Blade up	800	650	560	460	430	350
	Blade down	*2000	700	*1420	490	*1070	380

CX30C Canopy

Lift point height (m)	kg	LIFT-POINT RADIUS					
		2.0 m		2.5 m		3.0 m	
1.0 m	Blade up			660	510	490	390
	Blade down			*1180	550	*930	420
0.0 m	Blade up	880	660	610	470	470	360
	Blade down	*1540	720	*1480	510	*1110	390
-1.0 m	Blade up	890	670	610	470	460	360
	Blade down	*1920	720	*1380	510	*1040	390

CX30C Cab

Lift point height (m)	kg	LIFT-POINT RADIUS					
		2.0 m		2.5 m		3.0 m	
1.0 m	Blade up			730	570	550	430
	Blade down			*1180	610	*930	460
0.0 m	Blade up	980	740	690	530	520	410
	Blade down	*1540	800	*1480	570	*1110	440
-1.0 m	Blade up	990	740	680	530	520	400
	Blade down	*1920	800	*1380	570	*1040	430

Lift point height (m)	Arm	LIFT-POINT RADIUS					
		2.0 m		3.0 m		4.0 m	

CX33C Canopy

Lift point height (m)	kg	LIFT-POINT RADIUS					
		2.0 m		3.0 m		4.0 m	
1.0 m	Blade up			610	410	380	260
	Blade down			*1120	450	*820	290
0.0 m	Blade up	1080	660	560	360	360	240
	Blade down	*1610	740	*1350	410	*910	260
-1.0 m	Blade up	1090	660	550	350	360	230
	Blade down	*2430	740	*1340	390	*860	260

CX37C Canopy

Lift point height (m)	kg	LIFT-POINT RADIUS					
		2.0 m		3.0 m		4.0 m	
1.0 m	Blade up			610	410	380	260
	Blade down			*1120	450	*820	290
0.0 m	Blade up	1080	660	560	360	360	240
	Blade down	*1610	740	*1350	410	*910	260
-1.0 m	Blade up	1090	660	550	350	360	230
	Blade down	*2430	740	*1340	390	*860	260

CX37C Cab

Lift point height (m)	kg	LIFT-POINT RADIUS					
		2.0 m		3.0 m		4.0 m	
1.0 m	Blade up			830	710	540	470
	Blade down			*970	770	*690	500
0.0 m	Blade up	*1320	1230	780	670	510	440
	Blade down	*1320	*1320	*1160	730	*770	480
-1.0 m	Blade up	1520	1240	770	660	510	440
	Blade down	*2060	1370	*1140	720	*750	480

All models are equipped with long arm, no bucket, std counterweight., rubber tracks

ISO 10567: Lifting capacity does not exceed 75% of tipping load or 87% of full hydraulic capacity.

* Indicates load limited by hydraulic capacity

ATTACHMENTS





CASE offers an integrated range of attachments

- Standard buckets from 0.025 to 0.135 m³ SAE Heaped capacity (width from 250 to 800 mm)
- Ditch cleaning buckets
- Mechanical and hydraulic quick couplers (Klac and Lehnhoff-compatible)
- Hydraulic hammers









CX26C

-  **Weight (Canopy / Cab) (kg):** 2500 / 2650
-  **Power (kW / hp):** 18.5 / 24.8
-  **Width (mm):** 1500
-  **Digging depth (Short / Long arm) (mm):** 2420 / 2645







CX30C

-  **Weight (Canopy / Cab) (kg):** 2895 / 3005
-  **Power (kW / hp):** 18.5 / 24.8
-  **Width (mm):** 1550
-  **Digging depth (Short / Long arm) (mm):** 2500 / 2720







CX33C

-  **Weight (Canopy / Cab) (kg):** 3095 / -
-  **Power (kW / hp):** 18.2 / 24.4
-  **Width (mm):** 1550
-  **Digging depth (Short / Long arm) (mm):** 3035 / 3335



CX37C

-  **Weight (Canopy / Cab) (kg):** 3620 / 3760
-  **Power (kW / hp):** 18.2 / 24.4
-  **Width (mm):** 1740
-  **Digging depth (Short / Long arm) (mm):** 3135 / 3440

www.casece.com

EXPERTS FOR THE REAL WORLD
SINCE 1842

CASE
CONSTRUCTION



Form No. 20181GB - MediaCross Firenze - 03/19

**CNH INDUSTRIAL
DEUTSCHLAND GMBH**
Case Baumaschinen
Benzstr. 1-3 - D-74076 Heilbronn
DEUTSCHLAND

CNH INDUSTRIAL FRANCE, S.A.
16-18 Rue des Rochettes
91150 Morigny-Champigny
FRANCE

CNH INDUSTRIAL - UK
First Floor, Barclay Court 2,
Heavens Walk,
Doncaster - DN4 5HZ
UNITED KINGDOM

CNH INDUSTRIAL - SOUTH AFRICA
Waterfall Business Park
Bekker Street, Howick Close
1685 Midrand - Johannesburg
REPUBLIC OF SOUTH AFRICA

**CNH INDUSTRIAL
MAQUINARIA SPAIN, S.A.**
Avenida Aragón 402
28022 Madrid
ESPAÑA

CNH INDUSTRIAL ITALIA SPA
Strada di Settimo, 323
10099 San Mauro Torinese (TO)
ITALIA

**CASE CUSTOMER CENTRE
PARIS**
RN 330 - Penchard
77122 - Monthyon
FRANCE

CNH INDUSTRIAL - MIDDLE EAST
DAFZA - Dubai Airport Free Zone
West Wing 4 B, Office 642
P.O. Box 54588, Dubai,
UNITED ARAB EMIRATES

NOTE: Standard and optional fittings can vary according to the demands and specific regulations of each country. The illustrations may include optional rather than standard fittings - consult your Case dealer. Furthermore, CNH Industrial reserves the right to modify machine specifications without incurring any obligation relating to such changes.

Conforms to directive 2006/42/EC

CASE
00800-2273-7373

The call is free from a land line.
Check in advance with your Mobile Operator if you will be charged. Toll free number not available from all calling areas.